

WOLTERS ENGINEERING

ENGINEERING, DRAFTING, CONSULTING

15211 97th Road N
West Palm Beach, FL 33412
Ph/Fx: (561) 225-1982

PRODUCT EVALUATION (Florida Product Approval)

PRODUCT: **DM CLASS 1500 16 Oz or 20 Oz Copper 1 1/2" Mechanical Seam
12" or 16" Wide Roof Panel**
(FLPA# 41724.9)

MANUFACTURER:



Dynamic Metals, LLC
2951 SE Dominica Terrace
Stuart, FL 34997

or

Dynamic Metals, LLC.
2177 Andrews Lane
Ft. Myers, FL 33912

To all concerned,

The DM Class 1500 1 1/2" Mechanical Seam Roof Panel, manufactured by Dynamic Metals LLC, is a non-structural 16 oz. (min) copper roof panel (42 ksi min) that meets the requirements of Sections 1507.4 and 1518.9 of the 8th Edition (2023) Florida Building Code. The panel has been tested per TAS 100, TAS 125, and ASTM E2140 by Intertek B&C, with results shown in test reports P2196.37-450-34, P2196.38-450-44, and P2196.39-450-44. It has also been tested per TAS 110 by PRI Construction Materials Technologies, with results shown in test reports VLS-004-02-01 and VLS-005-02-01.

Technical Documentation:

1. Drawing "15CMS16-HZ" dated 1/24/24 (Rev. 1), signed and sealed by Scott Wolters, PE.
2. Test Reports listed above by Intertek B&C. signed and sealed by Vinu Abraham, PE.
3. Test Reports listed above by PRI Construction Materials Technologies, signed and sealed by Zachary R Priest, PE.
4. Supplemental Calculations to support 15CMS16-HZ, signed and sealed by Scott Wolters, PE.

I have reviewed this submittal per the requirements of FAC Product Approval Rule Chapter 61G20-3.005 (4). Based on the limitations listed below and those provided in the documents above, this product meets all of the requirements of the 8th Edition (2023) Florida Building Code generally, and chapter 15 specifically, including the HVHZ provisions.

Limitations: **This panel is approved for use inside and outside of the HVHZ.**

Overall Limitations:

Min. Slope: HVHZ: 1"/12"
Non-HVHZ: 1/4"/12"

Note: Slopes less than 3"/12" require lap sealant per FBC 1507.4

Maximum Panel Width: 16"
Minimum Rib Height: 1 1/2"
Panel Clip Anchors: 26 Ga. Stainless Steel, 2" long (Option #1)
3" long (Option #2)

	Option #1 Installation	Option #2 Installation
Max. Design Pressure:	-149 psf	-198.5 psf
Clip Anchor Spacing:	4" From Ends, 16" Max. O.C.	4" From Ends, 12" Max. O.C.
Min Panel Fasteners:	#10x1" Pancake Head Fasteners, (2) Per Clip	#10x1" Pancake Head Fasteners, (2) Per Clip
	Panels are Seamed to 90°	Panels are Seamed to 90°
Panel Seam Sealant: (Typical Installation)	Not Required	Not Required
Panel Seam Sealant: (HVHZ with Slope less than 2"/12")	Continuous bead of Bostik 915 at top corner of male/female seam	Continuous bead of Bostik 915 at top corner of male/female seam

Underlayment: Minimum ASTM D 226 Type II, installed and anchored per FBC Section 1507.1.1.1 (min).
(or)

Any underlayment with a valid FLPA or Miami-Dade NOA

Note: Outside of the HVHZ, in areas with windspeeds < 170 mph, 1" round plastic caps meeting the requirements of FBC Section 1507.1.1.1 may be used to prevent galvanic reactions.

Fire Barrier: Where required by code, install an approved fire barrier. Refer to a current fire directory listing for fire ratings of this roofing system assembly as well as the location of the fire barrier within the assembly. (See note #2 below)

Note: Outside of the HVHZ, in areas with windspeeds < 170 mph, 1" round plastic caps meeting the requirements of FBC Section 1507.1.1.1, may be used to prevent galvanic reactions.

Minimum Substrate: 1/2" (15/32" min) 4-ply CDX Plywood or 3/4" solid wood planks (S.G. = .42 min) nailed to 2x rafters spaced 24" max. on center with 8d ring-shank nails spaced 6" max on center.

Note: The 3/4" wood planking must be installed as a solid deck and must be nailed or fastened in a manner equal to the deck above, or as specified by a Florida licensed Architect/Engineer.

Other Limitations:

1. Roof slope must meet requirements of FBC Sections 1507.4.2 or 1515.2.
2. Fire classification is not a part of this evaluation. Refer to a current Approved Roofing Materials Directory for fire ratings of this product.
3. Design of substrate is by others and is not a part of this evaluation.
4. All panel system perimeters, penetrations, and transitions to be flashed and sealed per the requirements of RAS 133.
5. Rational analysis, provided by a Florida licensed Architect/Engineer per FAS 61G20.3.005(e), may be used for project specific approval by the local authorities having jurisdiction.
6. Where required by the Florida Building Code, panels shall be labeled with the manufacturer's name and/or logo, and the following statement, "Dynamic Metals FLPA# 41724.9, DM Class 1500".

Re-Roofing:

The DM Class 1500 16 oz Copper 1 1/2" Mechanical Seam 16" Wide Roof Panel may be installed over a single layer of existing asphalt shingles, provided the existing roof meets the requirements of Section 1521 (HVHZ) or Section 1511 (outside of HVHZ) of the Florida Building Code.

Panel Forming:

These panels may be jobsite roll formed with the following Dynamic Metals machines, per approval of 3rd party QA provider, to the dimensions shown on Drawing 15CMS16-HZ:

SSQ-6800617	SSQ-5150216	SSQ-6810617
SSQ-6690517	SSQ-4560615	SSQ2U-4031121
5VC-0490718	5VC-0360516	SSQ2U-4041121
		SSQ2U-4051121

If you have any questions or need more information concerning this approval, please contact me.

Thank you,

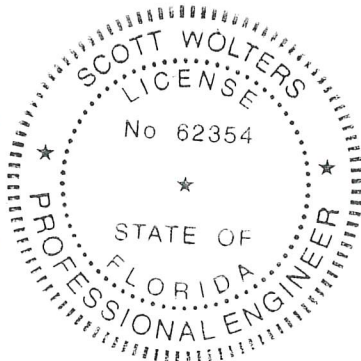

Scott Wolters
FL PE# 62354
JAN 24 2024

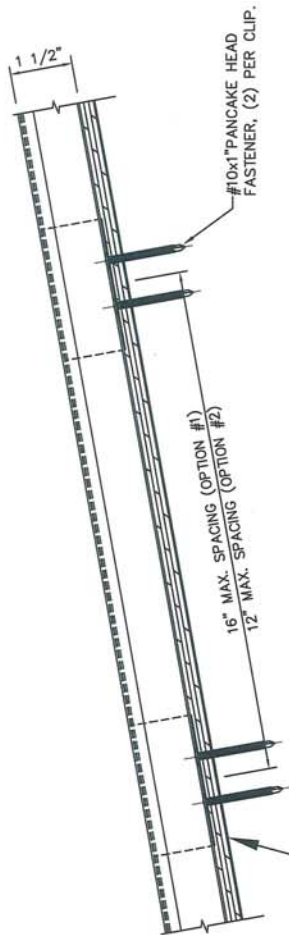

**DYNAMIC CLASS 1500 16 Oz. or 20 Oz. COPPER
1 1/2" MECHANICAL SEAM x 12" or 16" WIDE ROOF PANEL
OVER 1/2" PLYWOOD**

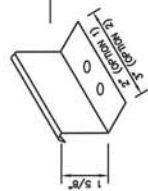

SECTION A-A



CONT. BEAD OF BOSTIK 915 IN TOP CORNER OF MALE/FEMALE PANEL SEAM. (REQ'D IN HVHZ WITH SLOPE < 2°/12" ONLY)

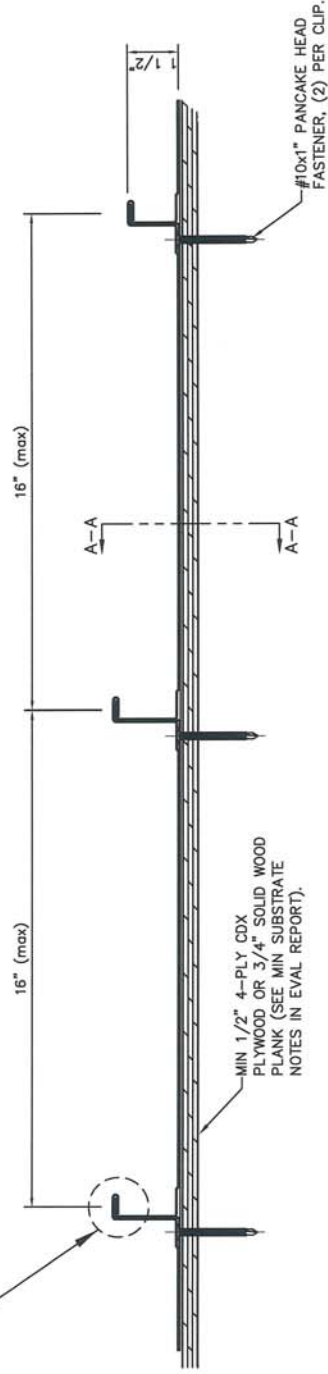
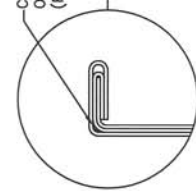

MAX DESIGN PRESSURE
-149 Psf (OPTION #1)
-198.5 Psf (OPTION #2)

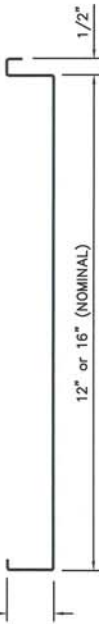

PANEL PROFILE

GENERAL NOTES:

1. ROOF SLOPE IS LIMITED PER THE REQUIREMENTS OF FBC SECTION 1507.4.2 or 1515.2.
2. DESIGN OF SUBSTRATE IS BY OTHERS AND NOT A PART OF THIS APPROVAL.
3. ALL PANEL SYSTEM PERIMETERS, PENETRATIONS, AND TRANSITIONS TO BE FLASHED AND SEALED PER THE REQUIREMENTS OF RAS 133.

DATE	REV.#	PRINTS ISSUED FOR
10/14/22	1	FAST SUBMITTAL
1/24/24	1	2023 CODE UPDATE



SCOTT WOLTERS
FL. P.E. # 62354
WOLTERS ENGINEERING
(CO# 27184)
15211 97TH ROAD N
WEST PALM BEACH, FL 33412
(561) 225-1982

DYNAMIC METALS
PH: (772) 247-2465
FAX: (772) 247-2466
PH: (239) 265-1638
EMAIL: info@dynamicmetals.net

2951 SE DOMINICA TERRACE
STUART, FL 34997
2177 ANDREWS LANE
FT. MYERS, FL 33912
www.dynamicmetals.net

