

DM Class 1750

1.75" Snaplock (18" Wide)
Standard Size

Approved for installation inside
the HVHZ (Miami-Dade & Broward
counties)

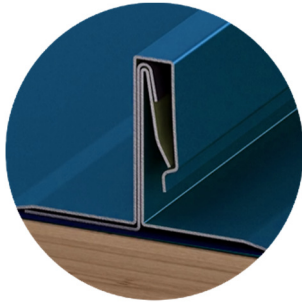

Panel Material (as tested):

Nominally 0.032" aluminum (or thicker).

Panel Description:

Snaplock panel with nominally 1.75" tall rib and 18" (max) coverage.

Deck/Substrate:

15/32" (min) plywood or 3/4" (min) thick wood plank (*min S.G. of 0.42*).

Available Options:

0.040" aluminum also available and acceptable (*0.040 is thicker than 0.032 min*).

12", 14", and 16" widths also available and acceptable (*12", 14", and 16" are less than 18" max*).

EVALUATED BY:



David Eng, PE

Timberlake Cove, LLC
FL PE 81377 • FL CA 33344
1317 Edgewater Dr Ste 2339
Orlando FL
www.timberlakecove.com

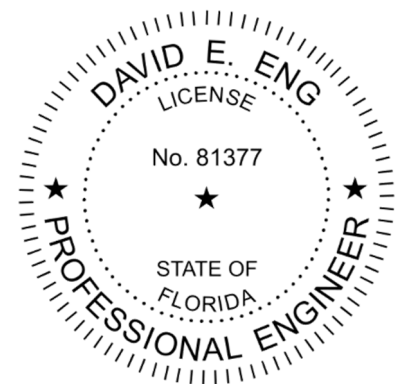

This item has been digitally signed and sealed by David Eng, PE on the date indicated. Printed copies of this document are not considered signed and sealed and the signature must be verified on any electronic copies.



STUART BRANCH

 (772) 247-2465
 2951 SE Dominica Terr.
Stuart, FL 34997

FORT MYERS BRANCH

 (239) 265-1638
 2177 Andrea Lane
Fort Myers, FL 33912

 www.dynamicmetal.net

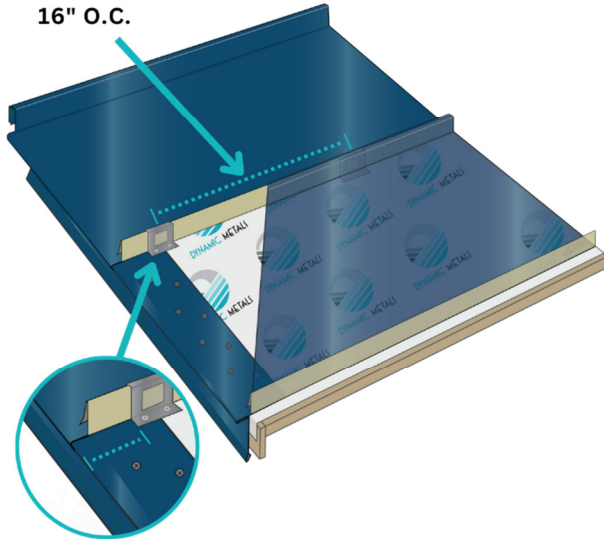
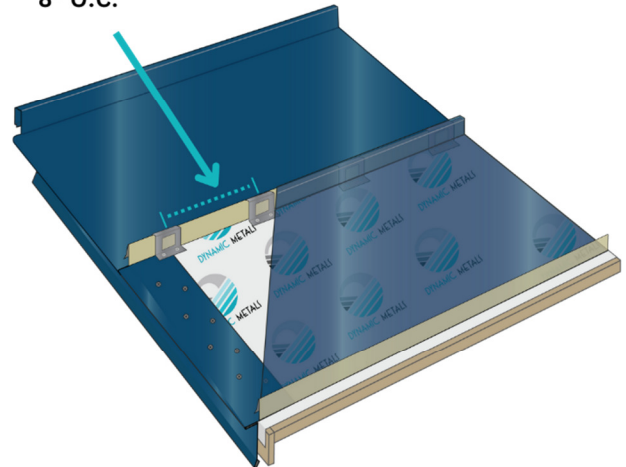

OPTION 1
CLIP SPACING
16" O.C.

APPROVED CLIPS
4" FROM ENDS
OPTION 2
CLIP SPACING
8" O.C.

	Option #1	Option #2
Max. Design Pressure (<i>allowable</i>)	-147.5 psf	-191 psf
Min. Fastener (<i>larger diameter and longer fasteners are acceptable</i>)	(2) #10 x 1" fastener per clip	(2) #10 x 1" fastener per clip
Clips	Nominally 1-13/16" high x 3.5" long 18ga clip	Nominally 1-13/16" high x 3.5" long 18ga clip
Clip Spacing	4" from ends, 16" max o.c.	4" from ends, 8" max o.c.



Notes:

Options #1 and #2 may be referred to as "field" and "corner" conditions, respectively. Compare *allowable* pressures required for the project to the maximum allowable design pressure above and select any option which meets or exceeds the pressures required for the project.



Installation graphics on this page are provided as a generic visual representation; specific written text in this product approval & applicable building code shall take precedence.

A factor of safety of 2.0 has been applied

STUART BRANCH

 (772) 247-2465
 2951 SE Dominica Terr.
 Stuart, FL 34997

FORT MYERS BRANCH

 (239) 265-1638
 2177 Andrea Lane
 Fort Myers, FL 33912

 www.dynamicmetal.net



Non-High Velocity Hurricane Zone (Non-HVHZ):

This product *is approved for installation* **outside** the HVHZ (Miami-Dade & Broward counties). References to HVHZ sections of the FBC (e.g. Fire Barrier) generally do not apply when the product is installed outside of the HVHZ.

High Velocity Hurricane Zone (HVHZ):

This product *is approved for installation* **inside** the HVHZ (Miami-Dade & Broward counties), and other jurisdictions which require HVHZ or NOA approvals. Comply with HVHZ elements of the FBC where required.

Underlayment:

Comply with local building code or FBC 1507.1.1/1518.2 where required.

Slope:

Comply with local building code or FBC 1507.4.2/FBC 1515.2 where required.

OUTSIDE the HVHZ, FBC 1507.4.2 minimum slope is 1/4:12.

INSIDE the HVHZ, FBC 1515.2 minimum slope is 2:12.

Trim and Flashing Details:

Outside the scope of this approval; refer to manufacturer's recommendations. Comply with RAS 133 where required.

Re-Roofing:

This panel may be installed over a single layer of existing shingles as permitted by local building code or FBC 1511/1521, provided the existing roof meets the conditions required by the applicable code. Size fasteners to fully penetrate ¼" (min) through substrate.

Fire Barrier:

Comply with FBC 1516.1 and 1516.2 where required. Optional where not required by code.

Technical Documentation:

This product has been tested to the TAS 125 / UL 580 standard by Intertek Testing (TST-1527), report G3443.45-450-44 and to TAS 100 under report H2688.02-450-44. Tests are owned by Lara IP, and used with permission.

Compliance Statement:

This product as described has demonstrated compliance with Florida Building Code 2023, 1504.3.2 (**non-HVHZ**) and 1518.9.1/1523.6.5.2.4 (**HVHZ**), as required by FL Rule 61G20-3, method 1D.

This product as described has been tested and demonstrated compliance with:

- UL580 – Test for Uplift Resistance of Roof Assemblies
- UL 1897 – Uplift test for roof covering systems
- TAS 125 – Standard Requirements for Metal Roofing Systems
- TAS 100 - Wind and Wind-Driven Rain

STUART BRANCH (772) 247-2465 2951 SE Dominica Terr.
Stuart, FL 34997**FORT MYERS BRANCH** (239) 265-1638 2177 Andrea Lane
Fort Myers, FL 33912www.dynamicmetal.net

Panel Labeling:

Products sold in the HVHZ that require labeling shall bear the following or similar label. Other labeling in accordance with FBC 1523.5 shall also be permitted.



City, State
DM Class 1750 FL #41724.13

Approved for
Miami-Dade County

Design Process:

Compare the maximum allowable loads to the ASD uplift pressures for the project to determine sufficiency and installation requirements. Determine project uplift pressures using ASCE 7-22, FBC R301, project design documents, guidance from local building department, or other design professionals. Engineering analysis may be completed by other licensed engineers for project specific approval by local authorities having jurisdiction.

Certification of Independence:

David Eng, PE and Timberlake Cove, LLC do not have, nor will acquire a financial interest in any company manufacturing or distributing products under this evaluation. The same entities do not have, nor will acquire, a financial interest in any other entity involved in the approval process of the product.

Exclusions and Limitations:

Design of deck and roof structure (to include attachment of plywood or wood plank) shall be completed by others. Fire classification and shear diaphragm design are outside the scope of this evaluation. Accelerated weathering/salt spray is outside the scope of this evaluation.



This report is limited to compliance with structural wind load requirements of FBC 1504.3.2, as required by Rule 61G20-3. Neither Timberlake Cove nor the manufacturer shall be responsible for any conclusions, interpretations, or designs made by others based on this evaluation report. This report is limited solely to documenting compliance with Rule 61G20-3, and makes no express or implied warranty regarding performance of this product. Installation shall be subject to the local building code and authority having jurisdiction; this report shall not be construed to supersede local codes in force.

Panel Forming:



Panels may be formed on the jobsite with the following Dynamic Metals machines, under a quality assurance program audited by an approved 3rd party QA auditor:

SSP-10751007, 5VC-0700123, SSQ2U-6470323, SSQ2U-6480323, SSQ-6800617, SSQ-6690517, 5VC-0490718, SSQ-5150216, SSQ-4560615, 5VC-0360516, SSQ-6810617, SSQ2U-4031121, SSQ2U-4041121, SSQU-4051121

STUART BRANCH

 (772) 247-2465
 2951 SE Dominica Terr.
Stuart, FL 34997

FORT MYERS BRANCH

 (239) 265-1638
 2177 Andrea Lane
Fort Myers, FL 33912

 www.dynamicmetal.net



Panel Detail

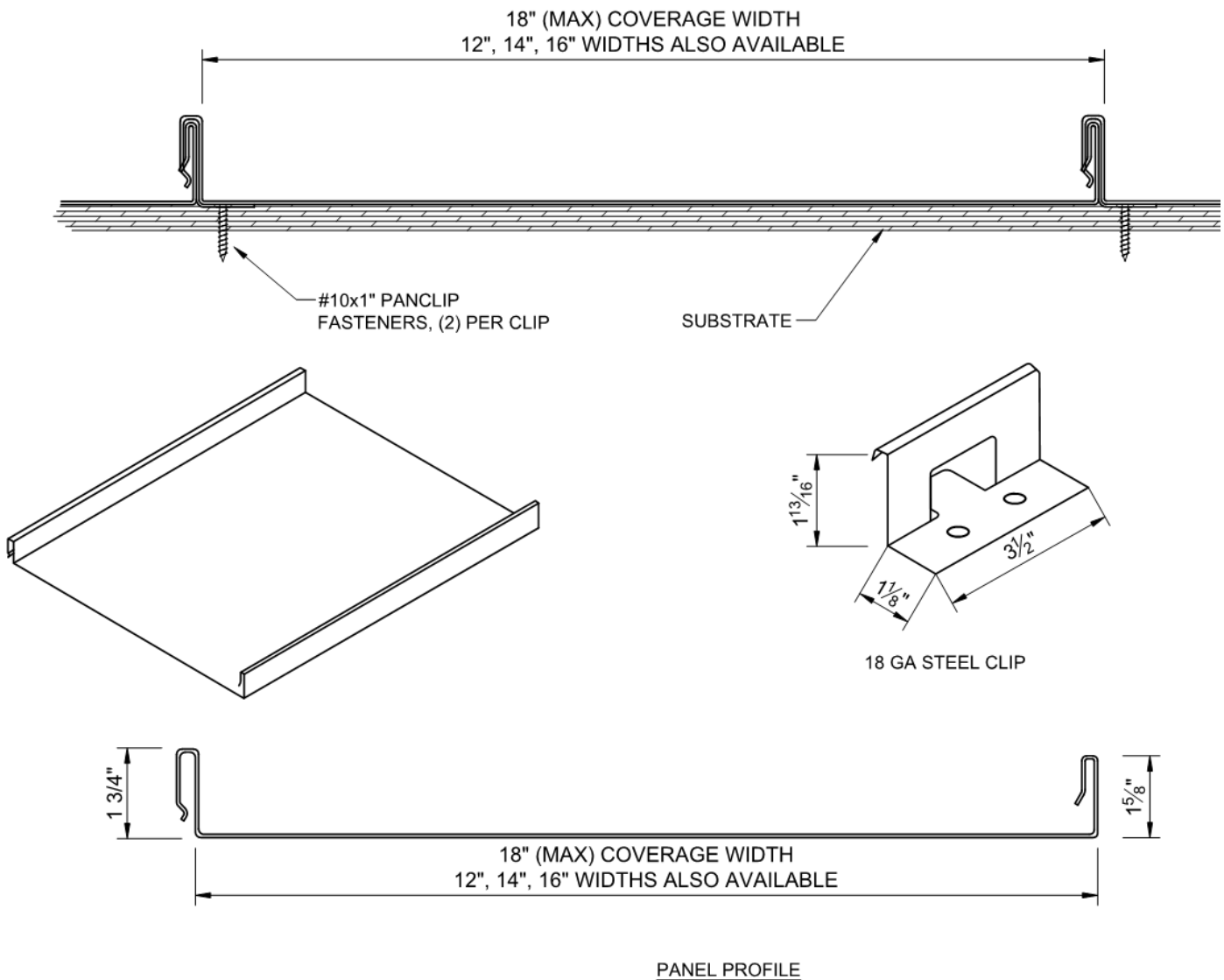

STUART BRANCH

(772) 247-2465
2951 SE Dominica Terr.
Stuart, FL 34997

FORT MYERS BRANCH

(239) 265-1638
2177 Andrea Lane
Fort Myers, FL 33912

